

## Instructions for use

2023-05-25

## CuroCell® M4/A4/IQ

Air mattress systems

Instructions for use item number: 95-001436-EN0000



7331345161211



# Table of contents

<b>1 Introduction</b> .....	<b>3</b>
1.1 General information .....	3
1.2 Intended use .....	3
1.3 Intended user.....	3
1.4 Intended use environment.....	3
1.5 Indications .....	3
1.6 Contraindications.....	3
1.7 Clinical benefit .....	4
<b>2 Assembly and installation</b> .....	<b>4</b>
<b>3 Common operations</b> .....	<b>6</b>
3.1 Sitting positioning in bed .....	6
3.2 CPR (Cardiopulmonary resuscitation) ..	6
3.3 Transport function .....	6
3.4 Restart .....	6
3.5 Maximum pressure notification.....	6
3.6 Power failure .....	6
<b>4 Operation CuroCell® M4</b> .....	<b>7</b>
4.1 Function .....	9
4.2 Programs .....	9
4.3 Maximum pressure (caring mode).....	9
4.4 Seating function.....	9
4.5 Panel lock.....	9
4.6 Hand check (function control).....	9
4.7 Sitting positioning in bed .....	10
4.8 CPR (Cardiopulmonary resuscitation).....	10
4.9 Transport function .....	10
4.10 Pack&Go® .....	10
4.11 Restart .....	10
4.12 Power failure .....	10
4.13 Notifications .....	10
4.14 Maximum pressure notification.....	10
4.15 Table of notifications.....	11

<b>5 Operation CuroCell® A4</b> .....	<b>12</b>
5.1 Function.....	14
5.2 Programs.....	14
5.3 Maximum pressure (caring mode) ...	14
5.4 Panel lock .....	14
5.5 Comfort settings.....	14
5.6 Hand check (function control) .....	15
5.7 Sitting positioning in bed.....	15
5.8 CPR (Cardiopulmonary resuscitation).....	15
5.9 Transport function.....	15
5.10 Pack&Go® function.....	15
5.11 Restart.....	15
5.12 Power failure .....	15
5.13 Notifications.....	16
5.14 Maximum pressure notifications.....	16
5.15 Table of notifications.....	16
<b>6 Operation CuroCell® IQ</b> .....	<b>18</b>
6.1 Function.....	20
6.2 Program .....	20
6.3 Maximum pressure (caring mode) ...	20
6.4 Hand check (function control) .....	20
6.5 CPR (Cardiopulmonary resuscitation).....	20
6.6 Transport function.....	21
6.7 Restart.....	21
6.8 Power failure .....	21
6.9 Notifications .....	21
6.10 Maximum pressure notifications.....	21
6.11 Table of notifications.....	22
<b>7 Product description</b> .....	<b>23</b>
7.1 Control unit (M4/A4/IQ).....	23
7.2 Mattresses.....	24
<b>8 Reuse and cleaning</b> .....	<b>27</b>
8.1 Cleaning and disinfection .....	27

8.2	Reconditioning.....	27
<b>9</b>	<b>Storage .....</b>	<b>29</b>
<b>10</b>	<b>Maintenance .....</b>	<b>29</b>
10.1	General.....	29
10.2	Between patients.....	29
10.3	Replacing the air filter .....	29
<b>11</b>	<b>Troubleshooting .....</b>	<b>30</b>
<b>12</b>	<b>Technical specification .....</b>	<b>31</b>
12.1	Standards.....	32
12.2	Symbol key.....	33
<b>13</b>	<b>Other information.....</b>	<b>35</b>
13.1	Recommended lifetime of the product .....	35
13.2	Disassembly and recycling.....	35
13.3	Returns .....	35



## **WARNINGS AND SAFETY PRECAUTIONS**

**Read all instructions before use or repair**

**WARNING! To minimize the risk of fire, personal injury and equipment/property damage adhere to the following instructions:**

1. The product must only be installed and used for its intended purpose according to the instructions in this manual and/ or other documentation from Care of Sweden. The product must not be combined, assembled or repaired with parts (e.g. control unit and mattress), accessories or spare parts other than those described in this manual or other documentation from Care of Sweden. The product must not be modified in any way.
2. The product must be placed and used so that it does not become trapped or damaged. Be particularly aware of trapping damage when using side rails. Always make sure that the mattress is the correct size for the bed.
3. Regularly check product functionality by performing a hand check.
4. When the product is used for individuals needing special supervision, such as children, continuous monitoring is required.
5. The mattress is protected by a hygiene cover; avoid using multiple hygiene covers as this can affect the vapor permeability of the mattress.
6. The hygiene cover does not allow liquid or air to penetrate but is vapour permeable. Make sure that the patient is positioned correctly to avoid the risk of suffocation.
7. Be careful with sharp objects to prevent damage to the hygiene cover.
8. Do not open the control unit housing – risk for electric shock. Servicing and maintenance must be performed by Care of Sweden or one of its authorized service technicians.
9. Route the power cable to the control unit carefully to avoid tripping. Also make sure that the patient is lying correctly on the mattress according to the instructions and use a cable holder if possible.
10. To avoid the risk of strangulation, make sure that the cable and tubes are routed to prevent someone getting caught up in them.
11. Do not use the product in bathrooms or other area where there is a risk of the control unit coming into contact with water or other liquids. Except for specified cleaning, never handle a product that has come into contact with water/liquid. Pull the plug out of the electrical socket immediately and send the product to an authorized service technician for servicing
12. Do not use close to or in contact with fire sources/hot surfaces, such as fire, burning cigarettes, hot lamps, heating fans or heating stoves/open fires as this could damage the product.
13. Do not store or use the product in direct sunlight. The product may be damaged by the elevated temperature and UV light.

14. Strong magnetic fields or wireless communication equipment (e.g., wireless home network products, mobile phones, walkie-talkies, cordless phones and their base stations, radio transmitters, etc.) may affect the product's functionality and should be kept at a distance of at least 1 meter from the control unit.
15. Never use the product if the power cable, plug of the control unit or power supply housing is defective, if the control unit housing is damaged, or if it is not functioning properly. Contact an authorized service technician for examination and repair.
16. Never connect anything other than the Care of Sweden supplied power supply to the control unit power cable connector.
17. Never use the external communication input (3,5mm connector), this input should only be used by the manufacturer.
18. If the hygiene cover is equipped with side handles, these are intended for managing or relocating the mattress. Do not use the handles to lift the mattress with the patient lying on it. All other use takes place under your own liability and is not covered by the product warranty.
19. To prevent the power supply from being pulled out, exercise caution when there are children and pets in the environment around the equipment.
20. Use of this product adjacent to or stacked with other equipment should be avoided because it could result in improper operation. If such use is necessary, this product and the other equipment should be observed to verify that they are operating normally.
21. To minimize the risk of wounds occurring on the feet, make sure that the patient doesn't come into contact with the hangers of the control unit.

# 1 Introduction

These air mattress systems may be used as an aid to prevent and treat pressure ulcers/pressure injuries.

**CuroCell® M4** is a control unit where the operator must manually adjust the pressure in the mattress based on the weight of the patient.

**CuroCell® A4** is a control unit that sets the air pressure in the mattress based on the patient's length, weight and position without need for manual settings. It offers the operator the option to adjust program and comfort.

**CuroCell® IQ** is a control unit that weights the patient and adjust the pressure without an option for the operator to choose program.

**CuroCell® M4, A4 and IQ** are compatible with five different mattresses: CuroCell® OP10 and CuroCell® CX10, CuroCell® CX15, CuroCell® CX16 and CuroCell® CX20.

See more information about the mattresses in section 7.2



Always read the instructions for use prior to use.

## 1.1 General information

The system is a medical device with CE marking in accordance with MDR (EU) 2017/745. According to this regulation the manufacturer is required to report all accidents or incidents involving the products. All information involving accidents or incidents relating to our products, shall be reported immediately to Care of Sweden.

## 1.2 Intended use

The mattress system consists of a control unit and a mattress and is intended to be used for prevention and as an aid in the treatment of pressure ulcers/pressure injuries (PU/PI).

## 1.3 Intended user

The mattress system is intended to be used by all kind of patients, including lay persons. Note that the patient and operator could be the same person. The mattresses are intended for use by patients of a recommended minimum length of 120 cm. The specifications for weight are listed in the following table.

Mattress	Recommended patient weight
CuroCell® OP10	≤ 160 kg
CuroCell® CX10	≤ 200 kg
CuroCell® CX15	≤ 220 kg
CuroCell® CX16	≤ 200 kg
CuroCell® CX20	≤ 250 kg

## 1.4 Intended use environment

The mattress system can be used in all kinds of health care environments, including home care.

## 1.5 Indications

Suitable for a wide range of patients with increased risk for pressure ulcers/injuries, including those with superficial ulcers, up to category 4 and unclassified PU/PI (unstageable and suspected deep tissue injury) in association with an individualized plan of care.

## 1.6 Contraindications

There are no known contraindications. It is necessary for the prescriber of the mattress to make an individual assessment of the patient and decide whether the characteristics of the mattress is beneficial for the patient based on diagnosis.

### 1.7 Clinical benefit

The clinical benefits for M4, A4 and IQ together with any of the mattresses included in this instruction for use are:

- Prevention and treatment of pressure ulcers/pressure injuries up to and including category 4 and unclassified PU/PI.
- Reduction of shear forces.
- Safety, comfort, pressure redistribution and easy to handle.
- Silent running control units.

#### Note!

- For certain patient, e.g., amputees, the recommended length measurement may not be reached. Patients in these groups may require other settings as the entire surface is not under load. For function controls, see section 3.
- The mattress may be inappropriate for use during x-ray examinations because of the risk of blurred images or artefacts that may lead to diagnostic errors.
- In the event of a power loss or similar, the mattress will retain air for at least 12 hours.

## 2 Assembly and installation

Check that no parts are damaged. If damage is found, contact Care of Sweden or your local distributor before using the product. Do not use sharp objects when unpacking as it might damage the product.

**When using an overlay mattress (CuroCell® OP10 or CuroCell® CX10):**

**1a.** Place the overlay mattress on the base mattress. Secure the mattress to the base using the 4 straps on the corners of the mattress.

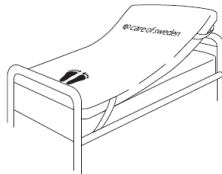

**When using a full replacement mattress (CuroCell® CX15, CuroCell® CX16 or CuroCell® CX20):**

**1b.** Place the mattress on the bed base.

Secure the mattress to the bed using the fastening straps on the underside of the mattress. If the mattress is used on an adjustable bed, the 4 straps at the head end shall be fastened at the moving part of the bed's head end. The 2 straps at the foot end of the bed shall be fastened at the moving part of the foot end.

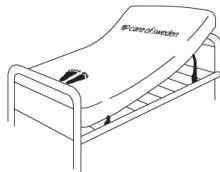

#### Note!

- Make sure that the mattress is the correct size for the bed.
- Check the cells and press studs to ensure they are correctly assembled.
- Make the bed with sheets.
- The mattress should be used lying in the lengthwise direction on the mattress, with feet at the end, marked with the feet symbol.



**2.** Hang the control unit on the foot end of the bed or place it on a level, steady surface. Check that the switch on the side of the control unit is set to '0' (off).



**3.** If the mattress is equipped with a cable holder, place the power cable in the cable holder by opening the press studs, placing the cable in the gap and closing the press studs again. Otherwise, place the power cable so there is no risk of stumbling over it, running over it with the bed wheels, or getting it jammed when raising or lowering the bed. Put the power cable into the control unit.

4. Open the lid on the air tube connector (marked CPR) and connect it to the side of the control unit.

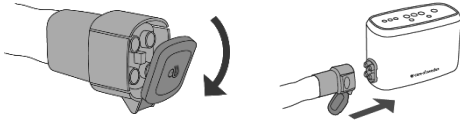

5. A click is heard and felt when correctly connected. Secure that both sides of the connection are closed.

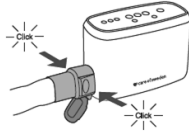

6. Plug the power supply into an approved and easily accessible electrical socket (100– 240 V).

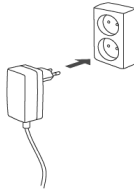

7. Check that the power cable has been correctly connected to the control unit and that the correct power supply has been used. (See section 9.1 Technical specification). The correct P/N is shown on the label on the power supply. The power supply is part of the equipment and may not be replaced.

If the control unit has been stored in its minimum or maximum storage temperature (-25°C to 70°C), wait at least 1 hour before starting it. This time is based on an ambient temperature of 20°C.

**Note!**

- Do not hold the 12V plug on the power supply while touching the patient.



### 3 Common operations

Following operations apply to CuroCell® M4, CuroCell® A4 and CuroCell® IQ regardless of which mattress that is used.

#### 3.1 Sitting positioning in bed

When raising the head end of the bed into a sitting position, always secure the patient's position. To ensure the product functionality, we always recommend to perform a hand check (see section 4, 5 or 6 depending on the control unit and mattress of interest). This function is recommended to use for short periods only. For additional support, positioning pillows can be used.

#### Note!

- When using a lift to place the patient in the bed and the head end of the bed is raised, make sure that the patient is not placed too high on the mattress. Otherwise, there is a risk of shear.
- When the alternating or pulsating program is used and the head end of the bed is raised, make sure that the patient and/or the mattress is not moving downwards due to the movement in the mattress. Also raise the foot end of the bed.

#### 3.2 CPR (Cardipulmonary resuscitation)

In case of an emergency where CPR (Cardiopulmonary resuscitation) is necessary, remove the connection (marked 'CPR') from the control unit and leave the lid open in order to empty the mattress of air quickly.

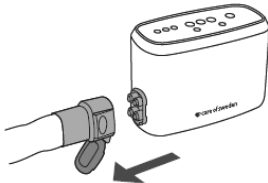

#### 3.3 Transport function

If the patient needs to be moved in bed, either:

- Unplug the CPR connection, close the lid, place the CPR connection at the end of the bed and remove the control unit from the bed. The mattress will retain air for at least 12 hours.

Or

- Remove the power supply from the wall socket and leave the control unit hanging on the bed during transport. The mattress will retain air for at least 12 hours.

We recommend using this function for short periods only.

#### 3.4 Restart

If a restart is required, set the On/Off switch on the side of the control unit to 0 (Off). Wait for approx. 10 seconds and restart the control unit.

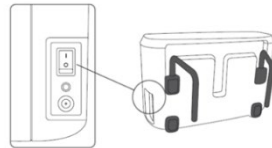

#### 3.5 Maximum pressure notification

When the function Maximum pressure has been used for a long time, the Maximum pressure diode will blink. If the use is intentional, ignore the notification.



#### 3.6 Power failure

In the event of a power failure, unplug the CPR connection, close the lid, place the CPR connection at the end of the bed and remove the control unit from the bed. The mattress will retain air for at least 12 hours. Perform a hand check to make sure the pressure of the mattress is not too hard or too soft.

## 4 Operation CuroCell® M4

Following operations apply only to CuroCell® M4 regardless of which mattress that is used. Read the label of the control unit carefully to make sure that you know which control unit you have.

### Operation CuroCell® M4 (how to get started)

1. Set the On/Off switch on the side of the control unit to position 1 (On). See figure 1.
2. Use the weight settings to set a suitable air pressure.
3. The mattress starts to inflate. This takes about 20-40 minutes depending on the size of the mattress. While the mattress is inflating, the “mute the information signal” and “information signal” diode light up in orange. When these diodes goes out, the patient can be placed on the mattress.
4. The pulsating mode setting is pre-set. If a different setting is desired, it can be selected when the patient is placed on the mattress.
5. When the patient is placed on the mattress and the desired program is selected, the inner pressure of the mattress is adjusted according to the selected weight setting. This takes about 10 minutes. During this time, the diode above the selected program flashes. When the diode stops flashing, the mattress is set and the inner pressure has reached the selected value.
6. Perform a hand check to ensure that the settings are correct.
7. If the mattress is too soft or too hard, adjust the weight setting.
8. Perform another hand check.

#### Note!





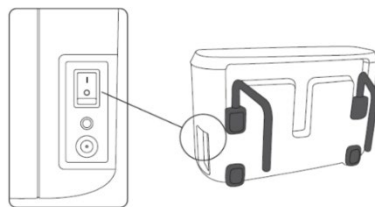





Each time the system starts up, it will operate as follows:

- When using a mattress without an air safety mattress (CuroCell® OP10, CuroCell® CX10 or CuroCell® CX16), the control unit will adjust to the set weight.
- When using a mattress with an air safety mattress (CuroCell® CX15 or CuroCell® CX20), the control unit always begins by completely inflating the safety mattress, followed by the other cells, and then perform an automatic setting. The mattress must be inflated before the patient can lie on the mattress. In both cases, the safety mattress will carry the load when the orange diode goes out.
- When using a mattress with a safety mattress in foam (CuroCell® CX16), the patient can lie on the mattress even when not inflated.

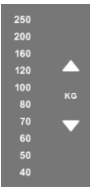

**Figure 1.** On/Off switch.

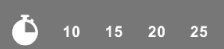

Button	Function
	Mute the information signal
	Panel lock
	Pack & Go®. Function for deflating the system
	Alternating mode
	Pulsating mode
	CLP mode (Constant low pressure)
	Maximum pressure (caring mode)
	Patient weight settings
	Information signal
	Incorrect connection of the air connector (CPR)
	Seating function
	Cycle time settings (10, 15, 20, 25 minutes). The diodes are also used for error notifications.

#### 4.1 Function

At start-up, the inner pressure of the mattress must be set manually based on the weight and height of the patient. The mattress system maintains the pre-set inner pressure regardless of movement and position changes. This means that when the patient changes position, for example, the mattress's inner pressure must be adjusted manually. The weight settings on the control unit are used to change the inner pressure.

#### 4.2 Programs

There are three programs to choose from:

**Constant low pressure (CLP)** means that the air pressure in all of the air cells is the same in the whole mattress.

**Alternating mode** means that the air pressure in the air cells are different and alternates regularly after chosen cycle periods.

**Pulsating mode** combines CLP with the alternating function.

Chose program by pushing the button for the program. We recommend the Pulsating mode which is also the preset mode.



**1. Constant low pressure mode (CLP)**  
No cycle period is needed.



**2. Alternating mode.** The cycle period can be changed according to the patient needs and requirements. Choose between 10, 15, 20 or 25 minutes. The longer the cycle period, the slower the alternations. We recommend a basic setting of 10 minutes.



**3. Pulsating mode.** The cycle period can be changed according to the patient needs and requirements. The longer the cycle period, the slower the alternations. We recommend a basic setting of 10 minutes.

#### 4.3 Maximum pressure (caring mode)



With this function, the entire mattress is inflated and provides firmed support. This function reverts to the previous setting after approximately 20 minutes. The function should be used when caring the patient, shifting the patient's position, or moving the patient in or out of bed. When the function has been used for a long time, the diode will blink. If the use is intentional, ignore the notification.

#### 4.4 Seating function



A visible and audible notification is generated when the seating function has been active for two consecutive hours, notifying that repositioning of the individual may be necessary. The control unit will also notify if an attempt is made to switch on the system while seating function is active.

#### 4.5 Panel lock



Press the Panel Lock button to lock or unlock the control panel. The button indicates when the panel has been locked. The screen locks automatically if left untouched for five minutes. This is to prevent the settings being changed accidentally. To unlock, press the button for 2 seconds.

#### 4.6 Hand check (function control)

Hand check is performed to ensure that the mattress system works properly and to ensure that the weight setting is correct. Hand check should be performed regularly; for CuroCell® M4, we recommend once per work shift as well as after installation of the system.

For manual systems hand check should also be performed when moving from lying to seating position in bed, in case of positioning changes and when changing the comfort setting (and/or the weight setting).

**Note!**

- Make sure that the mattress is filled, and that the system has adapted to the patient before performing a hand check.
- How to perform a hand check depends on which mattress is used – read the label of the mattress carefully to know which mattress you have.

**When using an overlay mattress system**

(CuroCell® OP10 or CuroCell® CX10):

1a. Open the cover and identify a cell with less air at the patient's sacrum. Insert a hand, with the palm facing up, between the overlay mattress and the underlying mattress. The hand is inserted beneath the patient's sacrum (center of mattress).

**When using a full replacement mattress**

(CuroCell® CX15, CuroCell® CX16 or CuroCell® CX20)

1b. Open the cover and identify a cell with less air at the patient's sacrum. Insert a hand, with the palm facing up, between the top cells and the underlying safety mattress. The hand is inserted beneath the patient's sacrum (center of mattress).

2. Ensure there is a gap between the patient and the underlying mattress so that the patient does not 'bottom out'.

3. If you can feel the patient's sacrum resting in the palm of your hand, the gap is too small. See section 11 'Troubleshooting'.

For more information about hand check, visit our website [www.careofsweden.com](http://www.careofsweden.com). Go to Customer Care and find informative videos.

**4.7 Sitting positioning in bed**

See 3.1

**4.8 CPR (Cardiopulmonary resuscitation)**

See 3.2

**4.9 Transport function**

See 3.3

**4.10 Pack&Go®**

The product may be packed as follows:



- Ensure that no-one is lying on the mattress.
- On the control panel, press the lock/unlock button.
- Press the Pack&Go® button and hold it down for 2 seconds

The Pack&Go® diode will flash during deflation. The control unit gives an audio signal once deflation is complete.

Carefully fold the mattress together, place the control unit between the folds of the mattress and place the system in a transportation bag (accessory) or equivalent for protective storage. Ensure that the power supply is packed complete.

**4.11 Restart**

See 3.4

**4.12 Power failure**

See 3.6

**4.13 Notifications**

Different notifications exist based on how serious the warning is. With a malfunction or an error, a notification will be given by way of a flashing warning triangle. To mute the warning signal, press the mute button.



When a notification occurs, the current cycle time diode will turn off and a notification code is shown on the four different cycle time diodes (10, 15, 20, 25). To read the cycle time during the error notification, unlock the control panel.







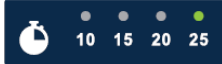

**4.14 Maximum pressure notification**

See 3.5

#### 4.15 Table of notifications

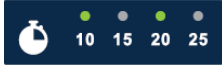
Information about each notification is shown in the notification table:

- Notifications from 1-7 are both audible and visual. The error code will be displayed until the error has been rectified. If the mute button is pressed the audible warning will cease for a period of 5 minutes and will return until the error has been rectified.
- The notifications 8-10 have no audible alarm. The error code is shown until the system is restarted.

Notification		Description and troubleshooting
1		High temperature. Valves and compressors are turned off. If the control unit is in direct sunlight, relocate it.
2		Default settings are not completed.
3		Incorrect input voltage. Make sure that the correct power supply is used.
4		Low pressure. Secure the CPR, mattress, air tubes and air filter.
5		High pressure. The pressure cannot be reduced to the desired value within the time limit.
6		The mattress control parameters have not been read. Connect the CPR.
7		The mattress control parameters have been changed during the use. Restart the system.
8		Leakage in one of the sections. Secure the CPR, mattress and connection tubes. Information to service technicians: this notification shows a leakage in the blue cell section. More information in the Servicemanual for CuroCell® M4.
9		Leakage in one of the sections. Secure the CPR, mattress and connection tubes. Information to service technicians: this notification shows a leakage in the green cell section. More information in the Servicemanual for CuroCell® M4.
10		Leakage in one of the sections. Secure the CPR, mattress and connection tubes. Information to service technicians: this notification shows a leakage in the red cell section. More information in the Servicemanual for CuroCell® M4.

If any of these problems remain, contact technical support.

## 5 Operation CuroCell® A4

Following operations apply only to CuroCell A4 regardless of which mattress that is used. Read the label of the control unit carefully to make sure that you know which control unit you have.

### Operation CuroCell® A4 (how to get started)

1. Set the On/Off switch on the side of the control unit to position 1 (On). See figure 1.
2. The mattress starts to inflate. This takes about 20-40 minutes depending on the size of the mattress. While the mattress is inflating, the "mute the information signal" and "information signal" diodes light up in orange. When these diodes goes out, the patient can be placed on the mattress.
3. The pulsating mode setting is pre-set. If a different setting is desired, it can be selected when the patient is placed on the mattress.
4. The control unit sets the inner pressure of the mattress according to the weight, length, and position of the patient. This takes about 20-30 minutes. During this time, the diode above the selected program flashes. When the diode stops flashing, the mattress is set and the inner pressure has adjusted according to the patient.
5. Perform a hand check to ensure that the settings are correct.

#### Note!

Each time the system starts up, it will operate as follows:

- When using a mattress without an air safety mattress (CuroCell® OP10, CuroCell® CX10 or CuroCell® CX16), the control unit will completely inflate the main cells and then perform an automatic setting.
- When using a mattress with an air safety mattress (CuroCell® CX15 or CuroCell® CX20), the control unit always begins by completely inflating the safety mattress, followed by the other cells, and then perform an automatic setting. The mattress must be inflated before the patient can lie on the mattress. In both cases, the safety mattress will carry the load.
- During the automatic setting, try to avoid larger movements on the mattress. Otherwise, you will get a notification on that the desired value could not be reached within the time limit and the weighting must start over.
- When using a mattress with a safety mattress in foam (CuroCell® CX16), the patient can lie on the mattress even when not inflated.
- Once automatic setting is complete, the control unit switches to a basic setting of Pulsating mode (when used for the first time) or to the previous setting. For more information see section 5.2.

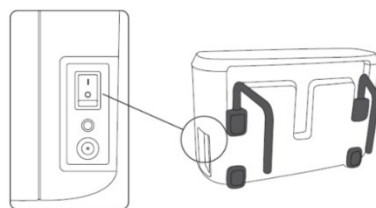

**Figure 1.** On/Off switch.



Button	Function
	Mute the information signal
	Panel lock
	Pack & Go®. Function for deflating the system
	Alternating mode
	Pulsating mode
	CLP mode (Constant low pressure)
	Maximum pressure (caring mode)
	Information signal
	Incorrect connection of the air connector (CPR)
	Cycle time settings (10, 15, 20, 25 minutes). The diodes are also used for error notifications.
	Comfort settings



## 5.1 Function

The mattress system independently and without manual adjustment controls the inner pressure of the mattress according to the weight, height, and position of the patient. No manual action needs to be performed to adjust the inner pressure of the mattress. This function works as follows:

1. At start-up, automatic setting of the inner pressure of the mattress is always carried out according to the weight and height of the patient.
2. If the patient moves noticeably or changes their position, the system will independently control the inner pressure of the mattress.
3. The system performs an automatic setting at fixed intervals even if no significant changes have occurred.

After automatic setting of the mattress inner pressure, the system returns to the previously selected program. At start-up, Pulsating Mode is always pre-set.

## 5.2 Programs

There are three programs to choose from:

**Constant low pressure (CLP)** means that the air pressure in all of the air cells is the same in the whole mattress.

**Alternating mode** means that the air pressure in the air cells are different and alternates regularly after chosen cycle periods.

**Pulsating mode** combines CLP with the alternating function.

Choose program by pushing the button for the program. We recommend the Pulsating mode which is also the preset mode.



1. **Constant low pressure mode (CLP)**  
No cycle period is needed.



2. **Alternating mode.** The cycle period can be changed according to the patient needs and requirements.

Choose between 10, 15, 20 or 25 minutes. The longer the cycle period, the slower the alternations. We recommend a basic setting of 10 minutes.



3. **Pulsating mode.** The cycle period can be changed according to the patient needs and requirements. The longer the cycle period, the slower the alternations. We recommend a basic setting of 10 minutes.

## 5.3 Maximum pressure (caring mode)

With this function, the entire mattress is inflated and provides firmed support. This function reverts to the previous setting after 20 minutes. The function should be used when caring the patient, shifting the patient's position, or moving the patient in or out of bed.



## 5.4 Panel lock

Press the Panel Lock button to lock or unlock the control panel. The button indicates when the panel has been locked. The screen locks automatically if left untouched for five minutes. This is to prevent the settings being changed accidentally. To unlock, press the button for 2 seconds.



## 5.5 Comfort settings

The pressure can be increased in two steps depending on the patient's comfort requirements. This increase is made based on the automatic setting in 5.1.

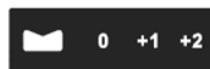

### Note!

- When only parts of the mattress are under load, for example, in the case of amputees – it may be necessary to raise the setting using the comfort settings.

The selected setting is shown by a green light.

## 5.6 Hand check (function control)

Hand check is performed to ensure that the mattress system works properly. Hand check should be performed regularly; for CuroCell® A4, we recommend once per work shift as well as after installation of the system.

### Note!

- Make sure that the mattress system is filled, which is shown by a green light from the diode, before performing a hand check.
- How to perform a hand check depends on which mattress is used - read the label of the mattress carefully to know which mattress you have.

### When using an overlay mattress system

(CuroCell® OP10 or CuroCell® CX10)

1a. Open the cover and identify a cell with less air at the patient's sacrum. Insert a hand, with the palm facing up, between the overlay mattress and the underlying mattress. The hand is inserted beneath the patient's sacrum (center of mattress).

### When using a full replacement mattress

(CuroCell® CX15, CuroCell® CX16 or CuroCell® CX20)

1b. Open the cover and identify a cell with less air at the patient's sacrum. Insert a hand, with the palm facing up, between the top cells and the underlying safety mattress. The hand is inserted beneath the patient's sacrum (center of mattress).

2. Ensure there is a gap between the patient and the underlying mattress so that the patient does not 'bottom out'.

If you can feel the patient's sacrum resting in the palm of your hand, the gap is too small. See section 11 'Troubleshooting'.

For more information about hand check, visit our website [www.careofsweden.com](http://www.careofsweden.com). Go to Customer Care and find informative videos.

## 5.7 Sitting positioning in bed

See 3.1

## 5.8 CPR (Cardiopulmonary resuscitation)

Se 3.2

## 5.9 Transport function

Se 3.3

### 5.10 Pack&Go® function



The product may be packed as follows: Ensure that no-one is lying on the mattress.



On the control panel, press the lock/unlock button.



Press the Pack&Go® button and hold it down for 2 seconds

The Pack&Go® diode will flash during deflation. The mattress will empty of air and be ready to be simply folded together within 20 minutes. The control unit gives an audio signal once deflation is complete.

Carefully fold the mattress together, place the control unit between the folds of the mattress and place the system in a transportation bag (accessory) or equivalent for protective storage. Ensure that the power supply is packed complete.

### 5.11 Restart

See 3.4

### 5.12 Power failure

See 3.6

### 5.13 Notifications



Different notifications exist based on how serious the warning is. With a malfunction or an error, a notification will be given by way of a flashing warning triangle. To mute the warning signal, press the mute button.













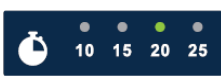

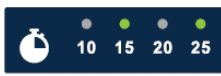
When a notification occurs, the current cycle time diode will turn off and a notification code is shown on the four different cycle time diodes (10, 15, 20, 25). To read the cycle time during the error notification, unlock the control panel.

### 5.14 Maximum pressure notifications

See 3.5

### 5.15 Table of notifications

Information about each notification is shown in the notification table on the next page (p. 17). Notifications from 1-10 are both audible and visual. The error code will be displayed until the error has been rectified. If the mute button is pressed the audible warning will cease for a period of 5 minutes and will return until the error has been rectified. The notifications 11-13 have no audible alarm. The error code is shown until the system is restarted.

Notification		Description and troubleshooting
1		High temperature. Valves and compressors are turned off. If the control unit is in direct sunlight, relocate it.
2		Default settings are not completed.
3		Incorrect input voltage. Make sure that the correct power supply is used, otherwise contact the technical support.
4		Low pressure. Secure the CPR, mattress, air tubes and air filter.
5		Automatic setting failure. The correct pressure has not been reached within the time limit.
6		Leakage under the automatic setting period. The mattress is leaking too much for the weighing to be accomplished. Control the mattress and the air connections.
7		High pressure. The pressure cannot be reduced to the desired value within the time limit.
8		The automatic setting has been restarted too many times during the automatic setting period.
9		The mattress control parameters have not been read. Connect the CPR.
10		The mattress control parameters have been changed during the use. Restart the system.
11		Leakage in one of the sections. Secure the CPR, mattress, and connection tubes. Information to service technicians: this notification shows a leakage in the blue cell section. More information in the Service manual for CuroCell® A4.
12		Leakage in one of the sections. Secure the CPR, mattress, and connection tubes. Information to service technicians: this notification shows a leakage in the green cell section. More information in the Service manual for CuroCell® A4.
13		Leakage in one of the sections. Secure the CPR, mattress, and connection tubes. Information to service technicians: this notification shows a leakage in the red cell section. More information in the Service manual for CuroCell® A4.

If any of these problems remain, contact technical support.

## 6 Operation CuroCell® IQ

Following operations apply only to CuroCell® IQ regardless of which mattress that is used. Read the label of the control unit carefully to make sure that you know which control unit you have.

### Operation CuroCell® IQ (how to get started)

1. Set the On/Off switch on the side of the control unit to position 1 (On). See figure 1.

2. The mattress starts to inflate. This takes about 20-40 minutes depending on the size of the mattress. While the mattress is inflating, the “silent information signal” and “information signal” diodes light up in orange. When these diodes goes out, the patient can be placed on the mattress.

3. The control unit sets the inner pressure of the mattress according to the weight, length, and position of the patient. This takes about 20-30 minutes. During this time, the diode above the “check symbol” flashes. When the diode stops flashing, the mattress is set and the inner pressure has adjusted according to the patient.

4. Perform a hand check to ensure that the settings are correct.





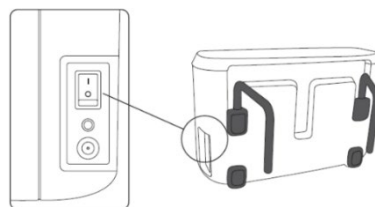

#### Note!

- Each time the system starts up, it will operate as follows:  
When using a mattress without an air safety mattress (CuroCell® OP10, CuroCell® CX10 or CuroCell® CX16), the control unit will completely inflate the main cells and then perform an automatic setting.
- When using a mattress with an air safety mattress (CuroCell® CX15 or CuroCell® CX20), the control unit always begins by completely inflating the safety mattress, followed by the other cells, and then perform an automatic setting.
- During the automatic setting, try to avoid larger movements on the mattress. Otherwise, you will get a notification on that the desired value could not be reached within the time limit and the weighting must start over.
- When using a mattress with a safety mattress in foam (CuroCell® CX16), the patient can lie on the mattress even when not inflated. When using a mattress with an air safety mattress (CuroCell® CX15 or CuroCell® CX20), this must be inflated before the patient can lie on the mattress. In both cases, the safety mattress will carry the load.



**Figure 1.** On/Off switch.



Button	Function
	Mute the information signal
	Pack & Go®. Function for deflating the system
	Maximum pressure (caring mode)
	Information signal
	Incorrect connection of the air connector (CPR)
	Check-symbol. System is ready to use
	Notification diodes

## 6.1 Function

The mattress system independently and without manual adjustment controls the inner pressure of the mattress according to the weight, length, and position of the patient. No manual action needs to be performed to adjust the inner pressure of the mattress. This function works as follows:

1. At start-up, automatic setting of the inner pressure of the mattress is always carried out according to the weight and length of the patient.
2. If the patient moves noticeably or changes their position, the system will independently control the inner pressure of the mattress.
3. The system performs an automatic setting at fixed intervals even if no significant changes have occurred.

After automatic setting, the system returns to Pulsating Mode.

## 6.2 Program

Pulsating mode with a cycle period of 10 minutes is preset.

## 6.3 Maximum pressure (caring mode)



With this function, the entire mattress is inflated and provides firmed support. This function reverts to the previous setting after 20 minutes. The function should be used when caring the patient, shifting the patient's position or moving the patient in or out of bed.

## 6.4 Hand check (function control)

Hand check is performed to ensure that the mattress system works properly. Hand check should be performed regularly; for CuroCell® IQ, we recommend once per work shift as well as after installation of the system.

### Note!

- Make sure that the mattress system is filled, which is shown by a green light from the diode, before performing a hand check.
- How to perform a hand check depends on which mattress is used - read the label of the mattress carefully to know which mattress you have.

### When using an overlay mattress system

(CuroCell® OP10 or CuroCell® CX10)

1a. Open the cover and identify a cell with less air at the patient's sacrum. Insert a hand, with the palm facing up, between the overlay mattress and the underlying mattress. The hand is inserted beneath the patient's sacrum (center of mattress).

### When using a full replacement mattress

(CuroCell® CX15, CuroCell® CX16 or CuroCell® CX20)

1b. Open the cover and identify a cell with less air at the patient's sacrum. Insert a hand, with the palm facing up, between the top cells and the underlying safety mattress. The hand is inserted beneath the patient's sacrum (center of mattress).

2. Ensure there is a gap between the patient and the underlying mattress so that the patient does not 'bottom out'.

3. If you can feel the patient's sacrum resting in the palm of your hand, the gap is too small. See section 11 'Troubleshooting'.

For more information about hand check, visit our website [www.careofsweden.com](http://www.careofsweden.com). Go to Customer Care and find informative videos.

## 6.5 CPR (Cardiopulmonary resuscitation)

See 3.2

## 6.6 Transport function

See 3.3Pack&Go®



The product may be packed as follows: Ensure that no-one is lying on the mattress. On the control panel, press the lock/unlock button. Press the Pack&Go® button and hold it down for 2 seconds

The Pack&Go® diode will flash during deflation. The mattress will empty of air and be ready to be simply folded together within 20 minutes. The control unit gives an audio signal once deflation is complete.

Carefully fold the mattress together, place the control unit between the folds of the mattress and place the system in a transportation bag (accessory) or equivalent for protective storage. Ensure that the power supply is packed complete.

## 6.7 Restart

See 3.4

## 6.8 Power failure

See 3.6

## 6.9 Notifications



Different notifications exist based on how serious the warning is. With a malfunction or an error, a notification



will be given by way of a flashing warning triangle. To mute the warning signal, press the mute button.



The notification code is shown on the four different diodes above the wrench symbol.

## 6.10 Maximum pressure notifications











See 3.5



## 6.11 Table of notifications

Information about each notification is shown in the notification table below.

- Notifications from 1-10 are both audible and visual. The error code will be displayed until the error has been rectified. If the mute button is pressed the audible warning will cease for a period of 5 minutes and will return until the error has been rectified.
- The notifications 11-13 have no audible alarm. The error code is shown until the system is restarted.

Notification		Description and troubleshooting
1		High temperature. Valves and compressors are turned off. If the control unit is in direct sunlight, relocate it. Otherwise, contact the technical support.
2		Default settings are not completed. Contact the technical support.
3		Incorrect input voltage. Make sure that the correct power supply is used, otherwise contact the technical support.
4		Low pressure. Secure the CPR, mattress, air tubes and air filter. If the problem remains, contact the technical support.
5		Automatic setting failure. The correct pressure has not been reached within the time limit. If the problem remains, contact the technical support.
6		Leakage under the automatic setting period. The mattress is leaking too much for the weighing to be accomplished. Control the mattress and the air connections. If the problem remains, contact the technical support.
7		High pressure. The pressure cannot be reduced to the desired value within the time limit. Contact the technical support.
8		The automatic setting has been restarted too many times during the automatic setting period. Contact the technical support.
9		The mattress control parameters have not been read. Connect the CPR or contact the technical support.
10		The mattress control parameters have been changed during the use. Restart the system. If the problem remains, contact the technical support.
11		Leakage in one of the sections. Secure the CPR, mattress, and connection tubes. Information to service technicians: this notification shows a leakage in the blue cell section. More information in the service manual for CuroCell® IQ.

If any of these problems remain, contact technical support.

## 7 Product description

Make sure that you read about the right product by looking at the label of the control unit as well as the mattress.

### 7.1 Control unit (M4/A4/IQ)

**CuroCell® M4** is a manual air mattress system used as an aid to prevent and treat pressure ulcers/pressure injuries. The inner pressure of the mattress must be set manually based on the weight of the patient. Perform a hand check to make sure the pressure is correct, see section 4.6. The mattress system maintains the pre-set inner pressure regardless of movement and position changes. This means that when the patient changes position, for example, the mattress's inner pressure must be adjusted manually.

**CuroCell® A4** is an automatic air mattress system used as an aid to prevent and treat pressure ulcers/pressure injuries. The automation means that the control unit's built-in sensors use software to adjust the inner pressure of the mattress according to the patient's weight, height, position, and change in position. This means that no manual action needs to be performed to adjust the inner pressure of the mattress to conform to the patient.

**CuroCell® IQ** is an automatic air mattress system used as an aid to prevent and treat pressure ulcers/pressure injuries. The automation means that the control unit's built-in sensors use software to adjust the inner pressure of the mattress according to the patient's weight, height, position, and change in position. This means that no manual action needs to be performed to adjust the inner pressure of the mattress to conform to the patient.

Any of these three control units are compatible with any of the mattresses in 7.2.

1. Control panel
2. Tube/CPR connection
3. Power switch, On/Off
4. 3,5 mm plug input  
(only for use by manufacturer)
5. Connection power cable
6. Air filter
7. Hangers
8. Power supply

CuroCell® M4



CuroCell® A4

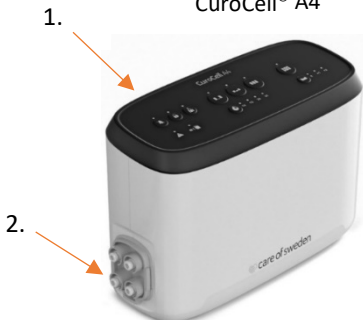

CuroCell® IQ



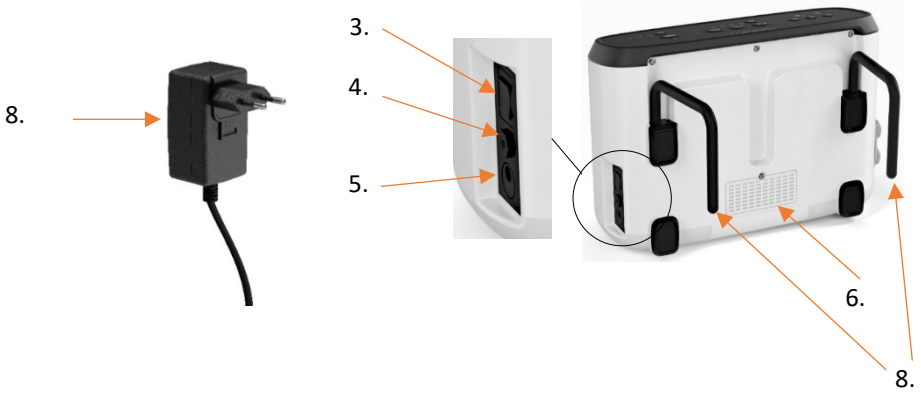

## 7.2 Mattresses

### 7.2.1 CuroCell® OP10

- 1. Mattress
- 2. Hygiene cover
- 3. Main cells
- 4. Heel cells
- 5. Tubing set
- 6. CPR (quick deflation)

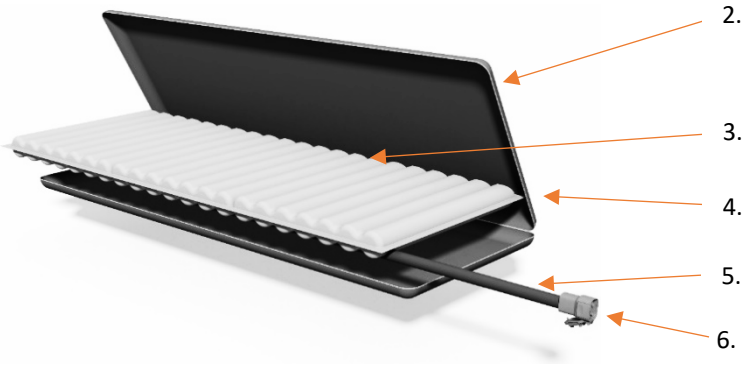

### 7.2.2 CuroCell® CX10

1. Mattress
2. Hygiene cover
3. Main cells
4. Cell holder (integrated in inner cover)
5. Heel cells
6. Press studs for inner cover
7. Tubing set
8. CPR (quick deflation)

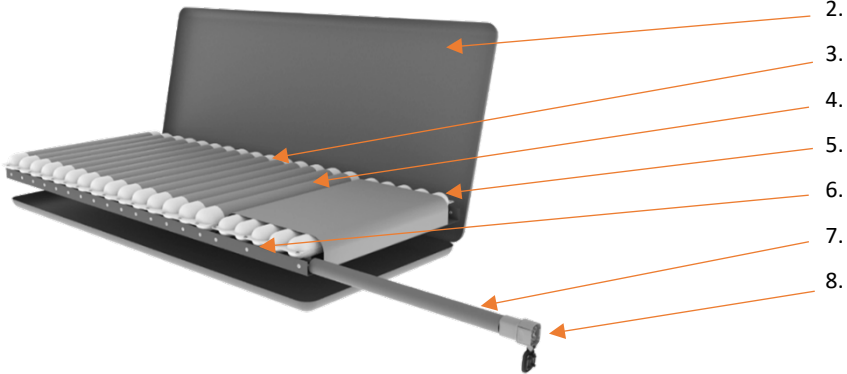

### 7.2.3 CuroCell® CX15

1. Mattress
2. Hygiene cover
3. Main cells
4. Cell holder (integrated in inner cover)
5. Heel cells
6. CPR (quick deflation)
7. Safety mattress
8. Tubing set
9. Press studs for inner cover
10. Hygiene cover – bottom part

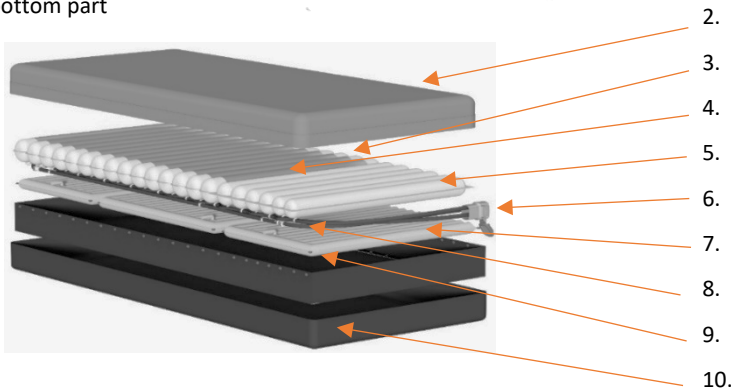

**7.2.4 CuroCell® CX16**

- 1. Mattress
- 2. Hygiene cover
- 3. Main cells
- 4. Cell holder (integrated in inner cover)
- 5. Press studs for inner cover
- 6. Safety mattress
- 7. Tubing set
- 8. CPR (quick deflation)
- 9. Bottom part

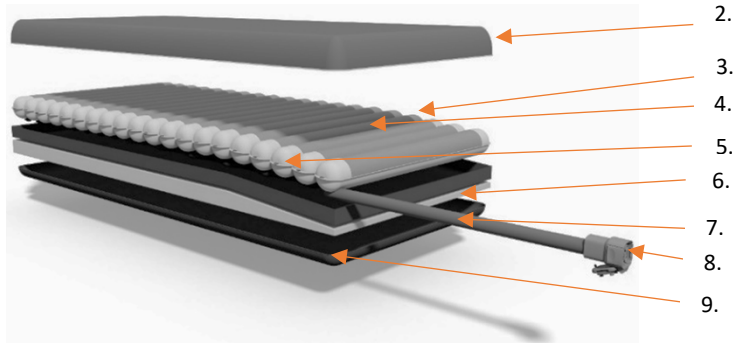

**7.2.5 CuroCell® CX20**

- 1. Mattress
- 2. Hygiene cover
- 3. Main cells
- 4. Cell holder (integrated in inner cover)
- 5. Heel cells
- 6. Safety mattress
- 7. Tubing set
- 8. Press studs for inner cover
- 9. CPR (quick deflation)
- 10. Hygiene cover – bottom part

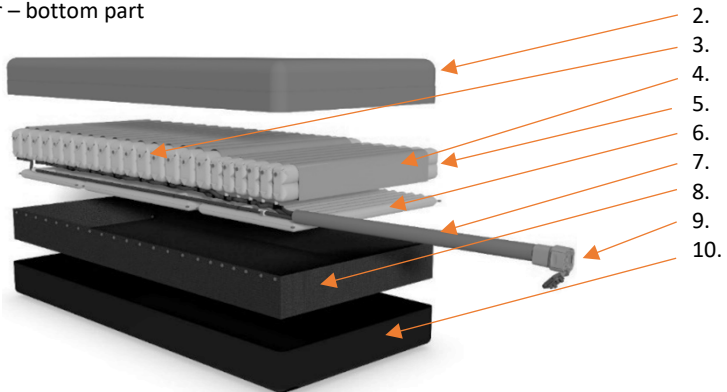

## 8 Reuse and cleaning

The product is reusable. Use the Pack&Go-function between users to reset the system. Before reusing, it is important to follow the instructions below for cleaning, disinfection, and reconditioning. Disinfection is recommended between patients according to the instructions below.

Always follow local instructions and the instructions for use of the cleaning and disinfecting agent. Consult your hygiene manager or Care of Sweden for help and instructions in case of uncertainty.

### 8.1 Cleaning and disinfection

#### CONTROL UNIT

Wipe the control unit with a damp cloth and mild detergent. Primarily use solvent-free soap with a neutral pH value. If necessary, a disinfectant and/or cleaning agent can be used such as: alcohol with or without surfactants or oxidizing solutions such as: chlorine and/or hydrogen peroxide, concentration 1000 ppm/0,1%. In exceptional cases, a maximum concentration of 10,000 ppm/1% can be used.

If another agent is used, choose one that does not harm the exterior of the control unit.

#### INNER COVER AND MATTRESS COVER

##### Wipe off



Primarily use solvent-free soap with a neutral pH value. For a daily basis cleaning, a disinfectant and/or cleaning agent can be used such as: alcohol with/without surfactants or oxidizing solutions such as: chlorine and/or hydrogen peroxide, concentration 1000ppm/0,1%. In exceptional cases, a concentration of a maximum of 10,000ppm/1% can be used, then consider that high concentrations can shorten the life of the coating.

##### Mechanical cleaning



Covers consisting of several parts must be separated before washing.

### 8.2 Reconditioning

#### CONTROL UNIT

Clean the control unit according to section 8.1 Cleaning and disinfection – Control unit.

#### MATTRESS

Disconnect the tube connector from the control unit and remove the air from the mattress.

Cleaning of mattress

1. Clean all external surfaces of the mattress according to section 8.1 Cleaning and disinfection - Inner cover and Mattress cover - Wipe off. Ensure that all areas are free of dirt residues.
2. If the mattress is heavily soiled, it is recommended that the mattress is taken apart and cleaned, follow the instructions below according to points 3-5.
3. Remove the covers.
4. Wipe off the cells, tubing and the CPR module with a cleaning agent according to local instructions and the instructions for use of the cleaning and disinfecting agent.
5. When all parts are dry, assemble the mattress. If cells have become detached from the tubes, these must be put back according to drawing in section 7.2.

#### Disinfection of mattress

1. Disinfect all external surfaces of the mattress with disinfectant according to section 8.1 Cleaning

and disinfection - Inner cover and Mattress cover - Wipe off. Ensure that all areas are free of dirt residue.

2. Allow the disinfectant to work according to the instructions from the manufacturer of the agent.

3. Let the cover dry.

4. If the mattress is heavily soiled, it is recommended that the mattress is taken apart and disinfected, follow the instructions below according to points 5-8.

5. Remove the covers.

6. Wipe the cells, tubes and the CPR module with a disinfectant.

7. Allow the disinfectant to work according to the instructions from the agent's manufacturer.

8. When all parts are dry, assemble the mattress. If cells have become detached from the tubes, they need to be put back according to the drawing in 7.2.

**Note!**

- Check the hygiene cover, cells and hoses each time the product is cleaned. If damaged, it must be replaced or repaired. Also check the control unit, tube connectors and power cable during cleaning. Damaged parts must be replaced or repaired.
- Do not wring or roll the foam core to extract the water. Let it dry in a warm, ventilated area (not in direct sunlight). The foam core must be completely dry before it is used again.

## 9 Storage

It is advisable to store the mattress and control unit in the product bag (accessory), original package or equivalent for protective storage. Handle the packaged product with caution. Do not place any heavy objects on top of it. For additional information about storage temperature, see section 12.

## 10 Maintenance

### 10.1 General

We recommend that the control unit will be regularly serviced and inspected to maintain functionality and performance.

Service and maintenance must always be performed by Care of Sweden or one of its authorized technicians. Only use spare parts approved by Care of Sweden. For more information, see the service manual for CuroCell® M4, A4 or IQ.

### 10.2 Between patients

Between patients, the Pack&Go function should be used to reset the system. When starting up the product again it will be set on the pulsating mode.

Between patients, also check that:

1. The power cable and power supply are undamaged.
2. The connecting tubes (marked CPR) on the side of the control unit are positioned correctly and not leaking.
3. The hygiene cover is intact and the cover and cells are correctly assembled.
4. No tubes or connectors are damaged or jammed.

Contact Care of Sweden or your local distributor if any spare parts are required.

### 10.3 Replacing the air filter

Before any maintenance is done, make sure that the control unit is turned off. Services shall not be done while using the product.

To replace the air filter:

1. Loosen the small protective plate on the rear of the control unit using a size T10 Torx screwdriver.



2. Remove the filter from the holder.
3. Place the new filter in the holder with the pink side facing outwards. Put the protective plate back in place and secure using the screws.

If the control unit is used in a dirty environment the filter should be checked regularly.





## 11 Troubleshooting

If the problem keeps occurring, please contact Care of Sweden or your local distributor.

Problem	Solution
The control unit does not start	Check that the power supply has been connected to the mains supply. Check that the LED on the power supply is showing green.
The patient is 'bottoming out'	<p>CuroCell® M4: Restart the control unit. See section 3.4. Perform a further hand check (see section 4.6). If the gap is still too small, raise the comfort setting in stages, be careful not to raise the setting too high.</p> <p>CuroCell® A4: Restart the control unit. See section 3.4. The control unit will initiate an automatic setting. Wait until the automatic setting is complete. Perform a further hand check (see section 5.6).</p> <p>CuroCell® IQ: Restart the control unit. See section 3.4. The control unit will initiate an automatic setting. Wait until the automatic setting is complete. Perform a further hand check (see section 6.4).</p>
The mattress moves around	Check that the mattress is fastened to the bed frame with the straps underneath (two at the head end and two on each of the long sides).
Some cells have less air	This is normal with a Pulsating or Alternating mode, as the air supply switches between alternating cells for a predetermined cycle period (one cycle = 10–25 minutes).
The control unit makes a noise; vibrations can be felt	Check how the control unit is hanging on the bed. Resonance can occur, in parts of the bed. Remove the control unit and listen to find out if this vibrations makes a difference. The problem may be resolved by putting the control unit on a flat, steady surface or by placing a towel between the control unit and bed.

## 12 Technical specification

**Note:** Care of Sweden reserves the right to modify the product specification at any time.

### CONTROL UNIT SPECIFICATION CUROCELL® M4/A4/IQ

Model		CuroCell® M4, A4, IQ
Input voltage		100-240 V / 50-60 Hz / 0,6 A
Output voltage		12 V DC
Power supply	Ungrounded AC outlet, electrical safety class II	Use only power supply P/N WR9QE1500LRPCIMG3138 Efficiency level: VI
Power consumption		Max 18W
Electrical classification		Class II, Type BF
Fuse		No Fuse
Mode of operation	CuroCell M4 / A4	Constant Low Pressure, Pulsating and Alternating program
	CuroCell IQ	Pulsating program
Cycle time	(Pulsating and alternating program)	10 min, 15 min, 20 min, 25 min
Patient pressure settings	CuroCell A4 / IQ	Automatic adjustment of patient pressure (internal air pressure) in the mattress
	CuroCell M4	Operator sets the patient pressure (internal air pressure) in the mattress according to the patient's weight. Correct settings to be controlled by handcheck.
Environmental	Temperature	Operation: +5 °C – 40 °C Storage: - 25 °C – 70 °C
	Version with backup battery	Storage: - 20 °C – 45 °C Transport: - 25 °C – 70 °C
	Humidity	Operation: 15 % – 93 % non-condensing Storage: < 93 % non-condensing
	Atmospheric	700 hPa – 1060 hPa
Dimensions (L x W x H)		11 cm x 30 cm x 20 cm
Weight		2.9 kg





## 12.1 Standards

The system is tested and approved according to the following European standards where applicable requirements are met.







IEC 60601-1	EN ISO 10993	ISO 3746
IEC 60601-1-2	EN 12182	ISO 11201
IEC 60601-1-11	EN 597 -1	
IEC 60601-1-6	EN 597-2	
IEC 62304	EN ISO 14971	

## 12.2 Symbol key









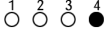
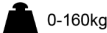

### Symbols to convey medical device information

	CE-marked in accordance with Medical Device Regulation (EU) 2017/745		Manufacturer
	Medical Device		Distributor
	UDI		



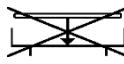

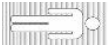







### Symbols for traceability and product information

	Item number		Type BF
	SN-number		Class II Equipment (double insulated). Indicated on the power supply.
	IP class (Enclosure class)	 EN 597-1 EN 597-2	Fire requirements

### Symbols for user information

XXXX-XX-XX	Year-Month-Day		Foot placement
CATEGORY 1 2 3 4 	Patient information – category	 0-160kg	Recommended patient weight
	Counteracts shear		Do not rotate
	Heel function		Do not turn around
	Place on top of existing mattress		Placed directly on the bed base
	Do not place directly on bed		Do not place on top of another mattress
 xxx cm	Minimum length		The mattress should be used with the patient lying lengthways
	Read the instructions for use		Read the instructions for use

## Symbols for cleaning and recycling

	Do not machine wash		Drip dry
	Machine wash at 70 °C		Do not iron
	Machine wash at 95 °C		Do not dry clean
	Tumble dry		Wipe clean
	Do not tumble dry		Chlorine
	Recycling		Do not dispose of with household waste

## 13 Other information

### 13.1 Recommended lifetime of the product

The estimated lifetime of this product is 7,5 years.

### 13.2 Disassembly and recycling

Except for certain parts of the control unit, energy recovery is possible for almost all material in CuroCell® products through incineration in waste incineration facilities.

#### Control unit:

The air tube connector (marked 'CPR') is easy to disassemble and is sorted as "plastic waste". The other parts of the control unit must not be disassembled and are sorted as "electronic waste".

#### Mattress:

A used CuroCell® mattress should be taken to a recycling center. The product is sorted as 'combustible waste'.

#### Note!

- If it is assessed that the product is or could be contaminated (e.g., used by patients with a known bloodborne infection), the product must be handled in accordance with the healthcare provider's or local authority's procedures for contaminated waste.

### 13.3 Returns

Contact Care of Sweden or your local distributor before returning the product.

**Your own notes**

---

---

---

---

---

---

---

---

---



Manufactured by

 care of sweden

SUPPORTING LIFE

**Contact:**

Phone: + 46 771 106 600

Fax: + 46 325 12840

Email: [export@careofsweden.se](mailto:export@careofsweden.se)

Internet: [www.careofsweden.com](http://www.careofsweden.com)

**Address:**

Care of Sweden AB

P.O. Box 146

SE-514 23 Tranemo

SWEDEN

**Visit address:**

Fabriksgatan 5A

SE-514 33 Tranemo

SWEDEN

**Cargo address:**

Byns väg 4A

SE-514 33 Tranemo

SWEDEN

**Distributed by:**